

**PARTS LIST
MODEL H6230-M**

No.	Description	Part No.
1	Retaining Ring (10/pk)	09464P-10
2	Right Dome	15253P-69
3	Dome Filter	26475P-02
4	Earphone Assembly	10376G-55
5	Screw/Grommet Kit (4 pk)	18900G-47
6	Dome Filter	25629P-03
7	Filter (1 each)	14096P-09
8	Undercut Gel Earseal (pair)	40863G-02
9	Filter (1 each)	26475P-08
10	Overhead Cord Kit	22607G-11
11	Headband Spring	15671P-01
12	Headpad Assy	40075G-02

No.	Description	Part No.
13	Stirrup & Clamp Kit	22378G-17
14	Clip, Cord (4/pk)	15350P-02
15	Left Dome	15253P-68
16	Boom Attachment Kit	12840G-19
17	Kit, Boom Assembly w/Att.	41090G-12
18	M-77 Electret Mic	09168P-35
19	Mic Protector/Windscreen	41090G-05
20	Connector w/Wires	18818G-05
21	Switch, Momentary	09851P-51
22	Lock Washer	09921P-25
23	Switch, Toggle	09494P-30
24	Switch Guard	13148P-01

ELECTRICAL SCHEMATIC MODEL H6230-M

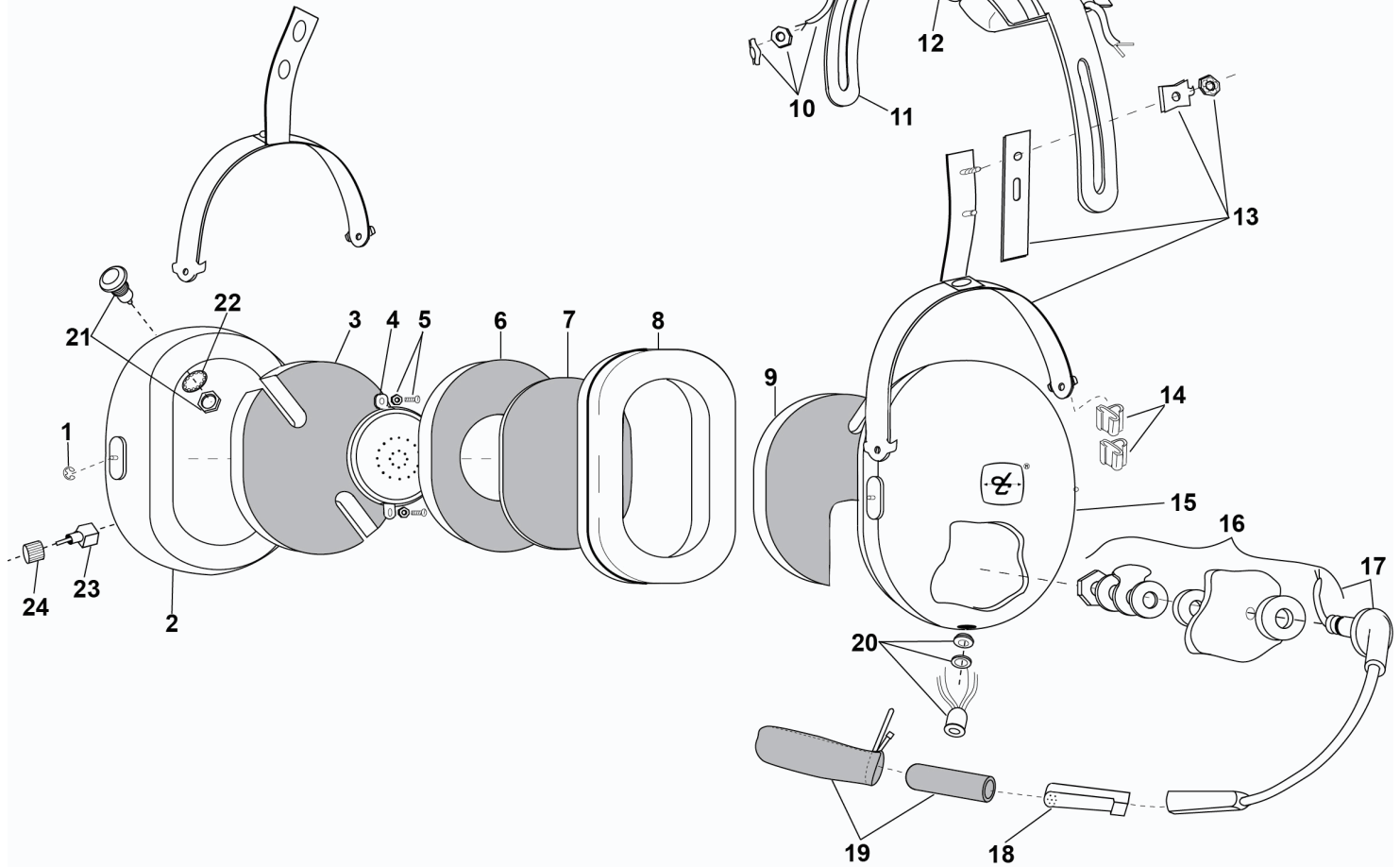
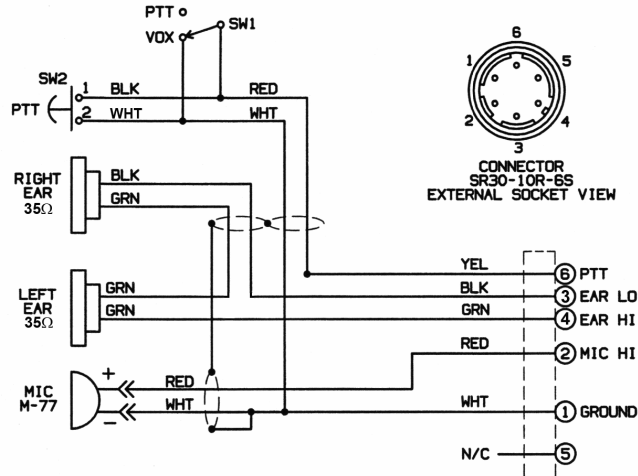

Headset-Mic H6230-M Operating Instructions

Setup

Please make sure that the radio on/off switch is in the "OFF" position.
Plug connector end of radio interface cord assembly to the accessory port on the radio.

Push-To-Talk

For push-to-talk operation, place the P.T.T./VOX switch in the P.T.T. mode.
Turn the radio on. (See note above)
The boom mounted microphone should be positioned 0 - 1/8 inch from user's lips. To transmit, press the push-to-talk switch located at the top of the left ear dome.
Release switch to receive transmissions.

VOX Operation

For voice operated transmission, place the P.T.T./VOX switch in the VOX mode.
Turn the radio on. (See note above)
The boom mounted microphone should be positioned 0 - 1/8 inch from user's lips. To transmit, speak clearly into microphone. The transmitter will remain keyed for a short time after speaking. This pause time will allow for radio VOX circuitry to shut off so that transmissions may be received. If system does not operate properly switch radio off. Select operating mode and turn radio on.

If repair is necessary under warranty, the manufacturer's facility, David Clark Company (508-751-5855), will serve as the repair depot. Return the product to the following address (include a brief description of the problem, a return address and daytime phone number):

David Clark Company, Inc.
360 Franklin Street
Worcester, MA 01604